



TDG 1703D

FITTING INSTRUCTION / INSTRUCTION DE MONTAGE / EINBAUANLEITUNG /
ISTRUZIONI PER L'USO / INSTRUCCIONES DE MONTAJE / MONTAGEHANDLEIDING



enjoy the journey.

KIA SPORTAGE

LUGGAGE PARTITION DIVIDER / PARTITION CENTALE DE COFFRE À BAGAGES /
ABTRENNUNG - GEPÄCKRAUMGITTER / RED DE DIVISIÓN DEL MALETERO /
DIVISORIO CENTRALE BAGAGLIAIO / DE VERDELER VAN DE BAGAGEVERDELING

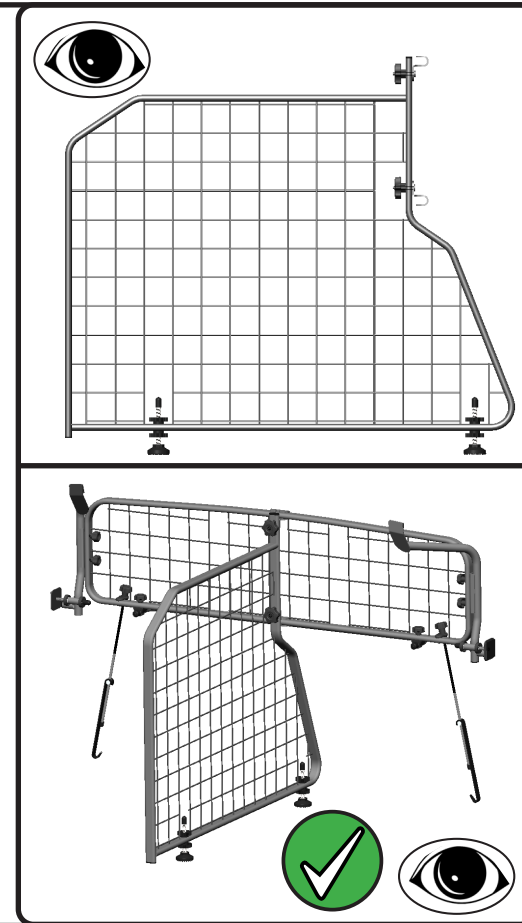

TRAVALL

The contents and parts shown in this fitting instruction is the property of TRAVALL therefore anything shown should not be used for any other manufacturing purposes, copied or replicated in any way without written authorisation from ©TRAVALL.

TRAVALL UNITED KINGDOM
GOSFORTH ROAD,
DERBY,
DE24 8HU,
United Kingdom,
E: Info@travall.com
T: +44(0)1332387630

The Travall Difference

Lifetime Warranty
100s of Applications

OEM Car Factory Supplier
Manufacturer for Over 30 Years





TDG 1703D

FITTING INSTRUCTION / INSTRUCTION DE MONTAGE / EINBAUANLEITUNG /
ISTRUZIONI PER L'USO / INSTRUCCIONES DE MONTAJE / MONTAGEHANDLEIDUNG



enjoy the journey.

KIA SPORTAGE

LUGGAGE PARTITION DIVIDER / PARTITION CENTALE DE COFFRE À BAGAGES /
ABTRENNUNG - GEPÄCKRAUMGITTER / RED DE DIVISIÓN DEL MALETERO /
DIVISORIO CENTRALE BAGAGLIAIO / DE VERDELER VAN DE BAGAGEVERDELING

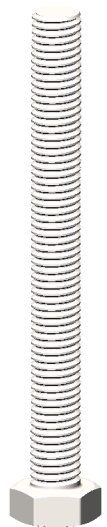
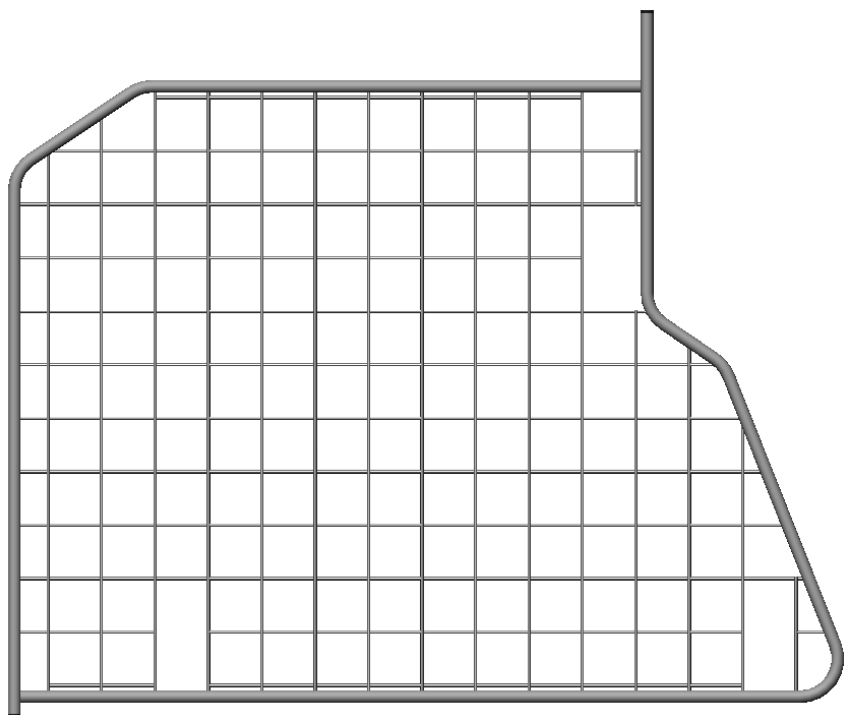

A x2
ASG-2304
M8 x 80mm

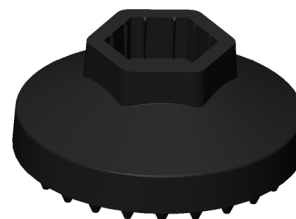

B x2
ASG-17001



C x2
ASA-0418



D x4
ASG-14878

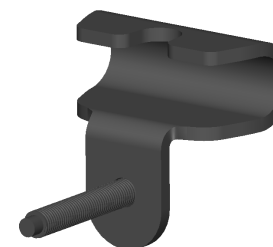

E x2
ASG-16704-SA

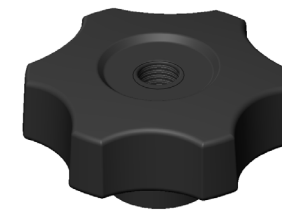

F x2
ASG-4377

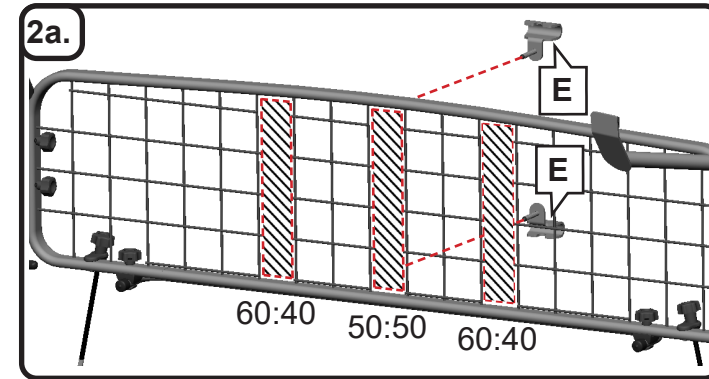
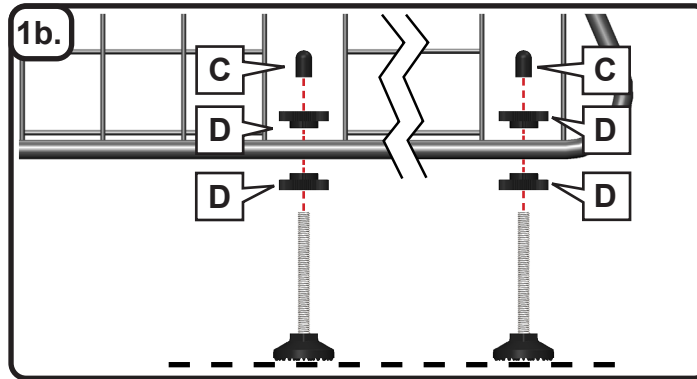
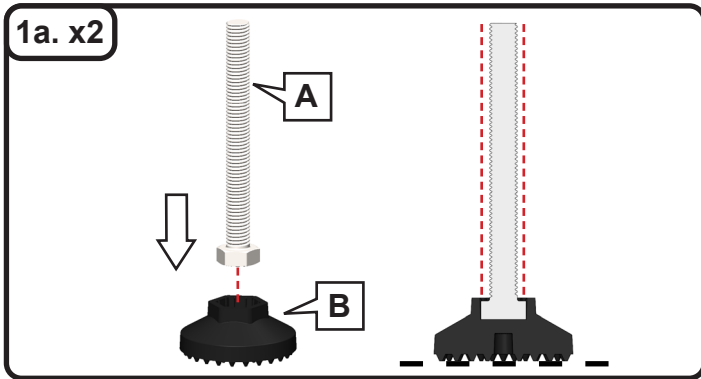

KIA SPORTAGE

LUGGAGE PARTITION DIVIDER / PARTITION CENTALE DE COFFRE À BAGAGES /
ABTRENNUNG - GEPÄCKKRAUMGITTER / RED DE DIVISIÓN DEL MALETERO /
DIVISORIO CENTRALE BAGAGLIAIO / DE VERDELER VAN DE BAGAGEVERDELING

